

X = Number of Stations

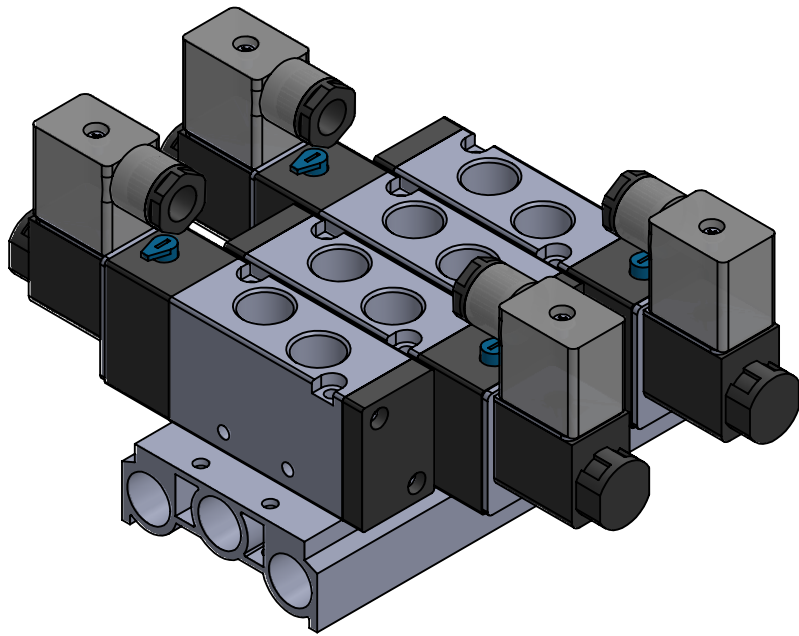

N.T.S.

Ø4.50, typ.
Mounting Holes (x4)

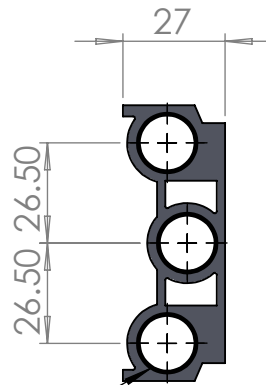

3/8" NPT

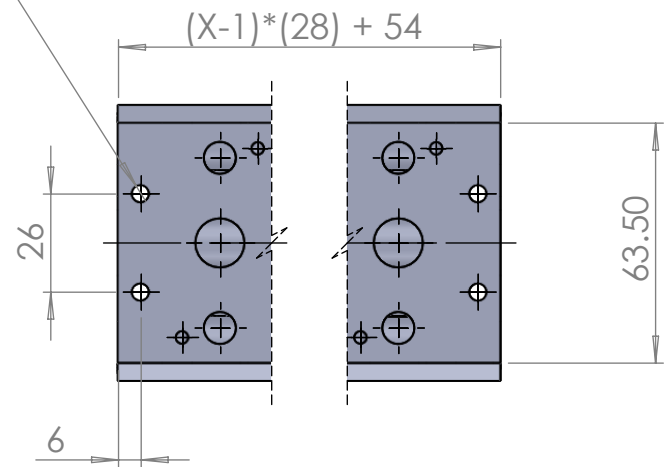

Part Number:

4V-300M-[X]

Manifold for 4V300 Series Solenoid Valves

11x8.5

kfi